

<b>Foreword .....</b>	<b>39</b>	<b>C.1 Operation of digital models .....</b>	<b>52</b>
<b>A.1 General information.....</b>	<b>40</b>	C.1.1 Digital thermoregulator and control panel .....	52
A.1.1 Introduction.....	40	C.1.1.1 Switching the appliance on .....	52
A.1.2 New concept appliances .....	40	C.1.1.2 Control panel buttons (fig. 2).....	52
A.1.3 Easy cleaning .....	40	C.1.2.2 Digital thermoregulator display.....	53
A.1.4 Recyclability and environmental impact.....	40	C.1.3 Alarms and signalling.....	53
A.1.5 Intended use and restrictions.....	40	C.1.3.1 Alarm silencing.....	53
A.1.6 Testing and inspection .....	40	C.1.4 Product loading .....	54
A.1.7 Definitions.....	40	<b>C.2 General safety rules .....</b>	<b>55</b>
A.1.8 Typographical conventions.....	41	C.2.1 Introduction.....	55
A.1.9 Machine and manufacturer's identification data.....	41	C.2.2 Protection devices installed on the machine.....	55
A.1.10 Appliance identification .....	42	C.2.2.1 Guards.....	55
A.1.11 Copyright .....	42	C.2.3 Safety signs to be placed on the machine or near its	55
A.1.12 Responsibility .....	42	area .....	55
A.1.13 Personal protection equipment .....	42	C.2.4 End of use.....	55
A.1.14 Keeping the manual.....	43	C.2.5 Instructions for use and maintenance.....	55
A.1.15 Recipients of the manual .....	43	C.2.6 Reasonably foreseeable improper use .....	55
<b>A.2 Technical data .....</b>	<b>43</b>	C.2.7 Residual risks.....	56
A.2.1 Materials and fluids used .....	43	<b>C.3 Normal machine use .....</b>	<b>57</b>
A.2.2 Dimensions, performance and consumption.....	43	C.3.1 Characteristics of personnel trained for normal machine	57
A.2.3 Mechanical safety characteristics, hazards.....	44	use .....	57
A.2.4 Climatic class .....	44	C.3.2 Characteristics of personnel enabled to operate on	57
<b>B.1 Transport, handling and storage .....</b>	<b>44</b>	the machine.....	57
B.1.1 Introduction.....	44	C.3.3 Operator for normal machine use.....	57
B.1.2 Transport: instructions for the carrier.....	44	<b>D.1 Machine cleaning and maintenance.....</b>	<b>57</b>
B.1.3 Handling .....	44	D.1.1 Routine maintenance .....	57
B.1.4 Procedures for handling operations.....	45	D.1.1.1 Precautions for maintenance .....	57
B.1.5 Translation.....	45	D.1.1.2 Cleaning the cabinet and accessories.....	57
B.1.6 Placing the load.....	45	D.1.1.3 Compartment cleaning .....	58
<b>B.2 Installation and assembly.....</b>	<b>45</b>	D.1.1.4 Precautions in case of long idle periods.....	58
B.2.1 The customer's responsibilities.....	45	D.1.2 Extraordinary maintenance.....	58
B.2.2 Machine space limits.....	45	D.1.2.1 Periodical condenser cleaning .....	58
B.2.3 Positioning.....	45	D.1.2.2 Replacing the power cable.....	59
B.2.4 Disposal of packing.....	46	D.1.2.3 Quick troubleshooting guide.....	59
B.2.5 Reversing opening of fully insulated doors .....	47	D.1.3 Maintenance intervals.....	59
B.2.6 Reversing opening of half doors .....	48	D.1.3.1 Maintenance frequency .....	59
B.2.7 Electrical connection .....	49	D.1.4 Disassembly .....	60
B.2.8 Electrical connection(only for appliances with cable	49	<b>D.2 Machine disposal .....</b>	<b>60</b>
without plug).....	49	D.2.1 Waste storage.....	60
B.2.9 Plumbing connection .....	49	D.2.2 Procedure regarding appliance dismantling macro	60
<b>B.3 Installation of Condensing Unit .....</b>	<b>50</b>	operations.....	60
B.3.1 Positioning.....	50	<b>D.3 Enclosed documents.....</b>	<b>61</b>
B.3.2 Responsibility of the customer (installer).....	50		
B.3.4 Creating a vacuum in the pipes and filling with the	51		
refrigerant .....	51		
B.3.4.1 Leak test.....	51		
B.3.4.2 Vacuum.....	51		
B.3.4.3 Filling with refrigerant .....	51		
B.3.5 Controls at first start-up of the system .....	51		

## Foreword

---



The installation, use and maintenance Manual (hereinafter Manual) provides the user with information necessary for correct and safe use of the machine (hereinafter "machine", "refrigerator" or "appliance").

The following must not be considered a long and exacting list of warnings, but rather a set of instructions suitable for improving machine performance in every respect and, above all, preventing injury to persons and animals and damage to property due to improper operating procedures.

All persons involved in machine transport, installation, commissioning, use and maintenance, repair and disassembly must consult and carefully read this manual before carrying out the various operations, in order to avoid wrong and improper actions that could compromise the machine's integrity or endanger people. Make sure to periodically inform the appliance user regarding the safety regulations. It is also important to instruct and update personnel authorised to operate on the machine, regarding its use and maintenance.

The manual must be available to operators and carefully kept in the place where the machine is used, so that it is always at hand for consultation in case of doubts or whenever required.

If, after reading this manual, there are still doubts regarding machine use, do not hesitate to contact the Manufacturer or the authorised after-sales service centre, to receive prompt and precise assistance for better operation and maximum efficiency of the machine.

During all stages of machine use, always respect the current regulations on safety, work hygiene and environmental protection. It is the user's responsibility to make sure the machine is started and operated only in optimum conditions of safety for persons, animals and property.

**The manufacturer declines any liability for operations carried out on the appliance without respecting the instructions given in this manual.**

**No part of this manual may be reproduced.**

## A.1 General information

**Thank you for choosing a quality product. We are sure our Premium refrigerator will meet all your needs for proper keeping of food.**

### A.1.1 Introduction

Given below is some information regarding the machine's intended use, its testing, and a description of the symbols used (that identify the type of warning), the definitions of terms used in the manual and useful information for the appliance user.

### A.1.2 New concept appliances

The "Premium" cupboard line has been created according to a new system that optimises performance and reduces energy consumption, also taking into account space requirements and environmental impact. This new system has several specific features:

- ▶ the door frame allows the side walls to be completely filled with foam insulation, whereas the inside part has been created in such a way as to increase the insulation.
- ▶ the ball-shaped door seal with three chambers has a double insulation area that reduces condensation and consumption.
- ▶ all the internal components (e.g. rear supports) are removable.
- ▶ the appliance has a conveyor that distributes the internal air flow uniformly, thereby allowing a uniform temperature to be maintained even when there is an excessive product load.
- ▶ the position of the compressor facilitates charging with gas.
- ▶ 2 types of refrigerant gas can be used : R134a/R404a or R290.

### A.1.3 Easy cleaning

The cupboard line is easy to clean thanks to the rounded corners and the possibility of removing all the internal components.

### A.1.4 Recyclability and environmental impact

The appliances have been designed also taking environmental impact into account, and therefore:

- ▶ cyclopentane is used for the foaming, which offers better insulation and is 100% environmentally friendly;
- ▶ the refrigerating units use an HFC (R134a/R404a) or HC (R290) refrigerant fluid allowed by the current regulations.
- ▶ the refrigerating unit can be removed in one piece;
- ▶ the appliance components are made from recyclable materials.

### A.1.5 Intended use and restrictions

Our appliances are designed and optimised in order to obtain high performance and efficiency. This appliance is designed for the refrigeration and preservation of foods. Any other use is deemed improper.

The appliance must not be used by people (including children) with limited physical, sensory or mental abilities or without

experience and knowledge of it, unless instructed in its use by those responsible for their safety.

**Attention: The machine is not suitable for installation outdoors and/or in places exposed to atmospheric agents (rain, direct sunlight, etc.).**

The manufacturer declines any liability for improper use of the product.

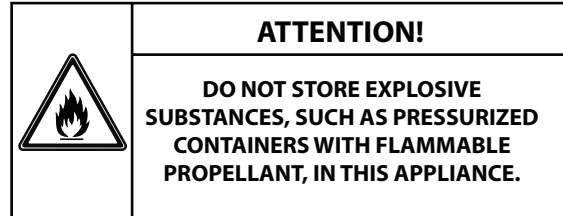

### A.1.6 Testing and inspection

Our appliances are designed and optimised, with laboratory testing, in order to obtain high performance and efficiency. The product is shipped ready for use.

Passing of the tests (visual inspection - electrical test - functional test) is guaranteed and certified by the specific enclosures.

### A.1.7 Definitions

Listed below are the definitions of the main terms used in the manual. Read them carefully before using the manual.

#### **Operator**

machine installation, adjustment, use, maintenance, cleaning, repair and transport personnel.

#### **Manufacturer**

Electrolux Professional SPA or any other service centre authorised by Electrolux Professional SPA.

#### **Operator for normal machine use**

an operator who has been informed and trained regarding the tasks and hazards involved in normal machine use

#### **Technical assistance or specialised technician**

an operator instructed/trained by the Manufacturer and who, based on his professional and specific training, experience and knowledge of the accident-prevention regulations, is able to appraise the operations to be carried out on the machine and recognise and prevent any risks. His professionalism covers the mechanical, electrotechnical and electronics fields.

#### **Danger**

source of possible injury or harm to health.

#### **Hazardous situation**

any situation where an operator is exposed to one or more hazards.

#### **Risk**

a combination of probabilities and risks of injury or harm to health in a hazardous situation.

#### **Protection devices**

safety measures consisting of the use of specific technical means (guards and safety devices) for protecting operators against dangers.

#### **Guard**

an element of a machine used in a specific way to provide

protection by means of a physical barrier.

### Safety device

a device (other than a guard) that eliminates or reduces the risk; it can be used alone or in combination with a guard.

### Customer

the person who purchased the machine and/or who manages and uses it (e.g. company, entrepreneur, firm).

### Electrocution

an accidental discharge of electric current on a human body.

## A.1.8 Typographical conventions

For best use of the manual, and therefore the machine, it is advisable to have good knowledge of the terms and typographical conventions used in the documentation.

The following symbols are used in the manual to indicate and identify the various types of hazards



**Attention!**  
**Danger for the health and safety of operators.**



**Attention!**  
**Danger of electrocution - dangerous voltage**



**Attention!**  
**risk of damage to the machine.**

Words further explaining the type of hazard are placed next to the symbols in the text. The warnings are intended to guarantee the safety of personnel and prevent damage to the machine or the product being worked.

The drawings and diagrams given in the manual are not in scale. They supplement the written information with an outline, but are not intended to be a detailed representation of the machine supplied.

The numerical values given on the machine installation diagrams refer to measurements expressed in mm.

## A.1.9 Machine and manufacturer's identification data

A reproduction of the marking or dataplate on the machine is given below:

F.Mod. NPT71FR PNC 9VTX 110115 14 W Tot. 0.26 kW	Comm.Mod. NPT71FR Ser.No. 50010001 Volt 230V 1N ~ 50Hz	V1MPTN Cyclopentane Total Current 2.1 A	2015
Potenza Sbrinamento / Defrost Power	0.18 kW	Classe / Class 5	
Resistenza Evaporazione / Evaporation Heater EL	0 kW	Refrigerante / Refrigerant R134a	0,13 Kg
Illuminazione / Lighting	0 W	Cap. 670	
NF nominal Charge			
Rated Pressure	Mpa		
	<b>IPX1</b>		
CE			
Electrolux Professional SPA - Viale Treviso, 15 - 33170 Pordenone (Italy)			

The dataplate gives the product identification and technical data.

The meaning of the various information given on it is listed below:

<b>F.Mod.</b>	factory description of product
<b>Comm.Model</b>	commercial description
<b>V1MPTN(*)</b>	certification group
<b>PNC</b>	production number code
<b>Ser.Nr.</b>	serial number
<b>230V 1N</b>	power supply voltage
<b>50 Hz</b>	power supply frequency
<b>0,26 kW</b>	max. power input
<b>Cyclopentane</b>	expanding gas used in insulation
<b>Total Current</b>	current absorbed
<b>Defrost Power</b>	defrost power
<b>Evaporation Heater El.</b>	heating element power
<b>Lighting</b>	inside light power
<b>Class</b>	climatic class
<b>Refrigerant</b>	type of refrigerant gas
<b>Cap.</b>	nominal capacity
<b>IPX1</b>	dust and water protection rating
<b>CE</b>	CE marking
<b>Electrolux Professional SPA Viale Treviso 15 33170 Pordenone Italy</b>	Manufacturer

### \* Description of certification group

<b>V</b>	Vertical refrigerator
<b>1M</b>	1 or 2 modules
<b>P</b>	Range (P=premium; G=Gab; M=mass; SP=Superpremium)
<b>TN</b>	Temperature range (TN=refrigerated; BT=freezer; TN/TN=refrigerated 2 temperatures; TN/BT=refrigerated/freezer 2 temperatures)
<b>HC</b>	R290

When installing the appliance, make sure the electrical connection is carried out in compliance with that specified on the dataplate.



**Attention!**  
**Do not remove, tamper with or make the machine "CE" marking illegible.**



**Attention!**  
**Refer to the data given on the machine "CE" marking for relations with the Manufacturer (e.g. when ordering spare parts, etc.)**



**Attention!**  
**When scrapping the machine, the "CE" marking must be destroyed.**



### A.1.10 Appliance identification

This manual applies to various refrigerator/freezer models. For further details regarding your model, refer to par. **A.2.2 Dimensions, performance and consumption.**

### A.1.12 Responsibility

The Manufacturer declines any liability for damage and malfunctioning caused by:

- ▶ non-compliance with the instructions contained in this manual;
- ▶ repairs not carried out in a workmanlike fashion, and replacements with parts different from those specified in the spare parts catalogue (the fitting and use of non-original spare parts and accessories can negatively affect machine operation and invalidates the warranty);
- ▶ operations by non-specialised technicians;
- ▶ unauthorised modifications or operations;
- ▶ inadequate maintenance;
- ▶ improper machine use;
- ▶ unforeseeable extraordinary events;
- ▶ use of the machine by uninformed and untrained personnel;
- ▶ non-application of the current provisions in the country of use, concerning safety, hygiene and health in the workplace.

### A.1.11 Copyright

This manual is intended solely for consultation by the operator and can only be given to third parties with the permission of Electrolux Professional SPA.







The Manufacturer declines any liability for damage caused by arbitrary modifications and conversions carried out by the user or the Customer.

The employer, workplace manager or service technician are responsible for identifying and choosing adequate and suitable personal protection equipment to be worn by operators, in compliance with regulations in force in the country of use. Electrolux Professional SPA declines any liability for any inaccuracies contained in the manual, if due to printing or translation errors.

Any supplements to the installation, use and maintenance manual the Customer receives from the Manufacturer will form an integral part of the manual and therefore must be kept together with it

### A.1.13 Personal protection equipment

Given below is a summary table of the Personal Protection Equipment (PPE) to be used during the various stages of the machine's service life.

Stage	Protective garments 	Safety footwear 	Gloves 	Glasses 	Ear protectors 	Mask 	Safety helmet 
<b>Transport</b>		●	○				○
<b>Handling</b>		●	○				
<b>Unpacking</b>		●	○				
<b>Assembly</b>		●	○				
<b>Normal use</b>	●	●	●*				
<b>Adjustments</b>	○	●					
<b>Routine cleaning</b>	○	●	●*	○			
<b>Extraordinary cleaning</b>	○	●	●	○			
<b>Maintenance</b>	○	●	○				
<b>Dismantling</b>	○	●	○				
<b>Scrapping</b>	○	●	○				

**Key:** ● PPE required; ○ PPE available or to be used if necessary;  DPI not required.

(\*) During **Normal use**, gloves protect hands from the cold tray when being removed from the appliance.

**Note:** the gloves to be worn during **Cleaning** are the type suitable for contact with the cooling fins (metal plates).

Failure to use the personal protection equipment by operators, specialised technicians or users can involve exposure to chemical risk and possible damage to health.

### A.1.14 Keeping the manual

The manual must be carefully kept for the entire life of the machine, until scrapping.

The manual must stay with the machine in case of transfer, sale, hire, granting of use or leasing.

### A.1.15 Recipients of the manual

This manual is intended for:

- ▶ the carrier and handling personnel;
- ▶ installation and commissioning personnel;
- ▶ the employer of machine users and the workplace manager;
- ▶ operators for normal machine use;
- ▶ specialised technicians - after-sales service (see service manual).

## A.2 Technical data

### A.2.1 Materials and fluids used

The areas in contact with the product are in steel or coated with non-toxic plastic material. An HFC(R134a(GWP:1430)/R404a(GWP:3922)) or HC refrigerant fluid for models with refrigerant R290, complying with the current regulations, is used in the refrigerating units. The type of refrigerant gas used is given on the dataplate.



#### Attention!

**R290 gas is potentially flammable and explosive! Take every possible precaution to prevent any risk linked to the nature of this gas during any routine and/or extraordinary operation carried out on the appliance. Only specialised personnel are authorised to operate on the appliance.**

### A.2.2 Dimensions, performance and consumption

External dimensions:	1 module	2 modules
width mm	710	1441
depth mm	837	837
height mm	2050	2050

#### Compartment dimensions

width mm	560	1291
depth mm	707	707
height mm	1544	1544

Rack dimensions mm	530x530	530x530
Gross capacity L	700	1400
Power supply voltage 230V/50HZ (*)		
Power supply voltage 220V/60HZ (*)		

(\*): depending on the model

Equivalent sound pressure level Leq (*) dB(A)	<70
---	-----

(\*) The value could increase depending on the workplace where measured.

#### Refrigerated models with fully insulated door

Temp. range in compartment C°	-2/+10
-------------------------------	--------

#### Refrigerated models with glass door

Temp. range in compartment C°	+2/+10
-------------------------------	--------

#### Freezer models with fully insulated door

Temp. range in compartment C°	-22/-15
-------------------------------	---------

#### Freezer models with glass door

Temp. range in compartment C°	-20/-15
-------------------------------	---------

#### Refrigerated models with separate compartments

Temp. range in compartment C°	-2/+10	-2/+10
-------------------------------	--------	--------

#### Ref/freezer models with separate compartments

Temp. range in compartment C°	-2/+10	-22/-15
-------------------------------	--------	---------

#### Refrigerated models with separate compartments and 3 doors

Temp. range in compartment C°	-2/+10	-2/-6
-------------------------------	--------	-------

### A.2.3 Mechanical safety characteristics, hazards

The appliance does not have sharp edges or protruding parts. The guards for the moving and live parts are fixed to the cabinet with screws, to prevent accidental access.

### A.2.4 Climatic class

The climatic class given on the dataplate refers to the following values:

CLIMATIC CLASS: 5

43°C (EN 60335-2-89)

40°C room with 40% relative humidity (EN ISO 23953).

CLIMATIC CLASS: 4

32°C (EN 60335-2-89)

30°C room with 55% relative humidity (EN ISO 23953).

## B.1 Transport, handling and storage

### B.1.1 Introduction

Transport (i.e. transfer of the machine from one place to another) and handling (i.e. transfer inside workplaces) must occur with the use of special and adequate means.



#### Attention!

**Due to their size, the machines cannot be stacked on top of each other during transport, handling and storage; this eliminates any risks of loads tipping over due to stacking.**

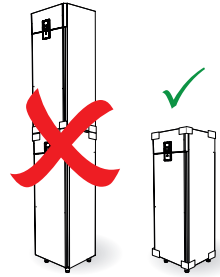

The machine must only be transported, handled and stored by qualified personnel, who must:

- ▶ have specific technical training and experience in the use of lifting systems;
- ▶ have knowledge of the safety regulations and applicable laws in the relevant sector;
- ▶ have knowledge of the general safety rules;
- ▶ ensure the use of personal protection equipment suitable for the type of operation carried out;
- ▶ be able to recognise and avoid any possible hazard.

### B.1.2 Transport: instructions for the carrier



#### Attention!

**Do not stand under suspended loads during loading/unloading operations. Unauthorised personnel must not enter the work area.**



#### Attention!

**The machine's weight alone is not sufficient to keep it steady. The transported load can shift:**

- when braking;
- when accelerating;
- in corners;
- on rough roads.

### B.1.3 Handling

Arrange a suitable area with flat floor for machine unloading and storage operations.



#### Attention!

**The appliance must be handled in the upright position. If the appliance is handled in a horizontal position, make sure to wait a few hours before making it operational**

### B.1.4 Procedures for handling operations

For correct and safe lifting operations:

- ▶ use the type of equipment most suitable for characteristics and capacity (e.g. electric pallet truck or lift truck);
- ▶ cover sharp edges;

Before lifting:

- ▶ send all operators to a safe position and prevent people from entering the handling area;
- ▶ make sure the load is stable;
- ▶ make sure no material can fall during lifting. Manoeuvre vertically in order to avoid impacts;
- ▶ handle the machine, keeping it at minimum height from the ground.



**Attention!**  
For machine lifting, do not use movable or weak parts such as: casings, electrical raceways, pneumatic parts, etc.

### B.1.5 Translation

The operator must:

- ▶ have a general view of the path to be followed;
- ▶ stop the manoeuvre in case of hazardous situations



**Attention!**  
Do not push or pull the appliance to move it, as it may tip over.

### B.1.6 Placing the load

Before placing the load, make sure the way is free and that the floor is flat and can take the load. Remove the appliance from the wooden pallet, move it to one side, then slide it onto the floor.

### B.1.7 Storage

The machine and/or its parts must be stored and protected against damp, in a non-aggressive place free of vibrations and with room temperature between -10°C and 50°C.

The place where the machine is stored must have a flat support surface in order to avoid any twisting of the machine or damage to the support feet.



**Attention!**  
Machine positioning, installation and disassembly must be carried out by a specialised technician.



**Attention!**  
Do not make modifications to the parts supplied with the machine. Any missing or faulty parts must be replaced with original parts.

## B.2 Installation and assembly

To ensure correct operation of the appliance and maintain safe conditions during use, carefully follow the instructions given below in this section.



**Attention!**  
The operations described below must be carried out in compliance with the current safety regulations, regarding the equipment used and the operating procedures.



**Attention!**  
Before moving the appliance make sure the load bearing capacity of the lifting equipment to be used is suitable for its weight.

### B.2.1 The customer's responsibilities

The Customer must:

- ▶ provide an earthed power socket of suitable capacity for the input specified on the dataplate;
- ▶ For information regarding the electrical connection, refer to par. **B.2.7 "Electrical connection"**;
- ▶ check the flatness of the surface on which the machine is placed.

### B.2.2 Machine space limits

A suitable space must be left around the machine (for operations, maintenance, etc.). This space must be increased in case of use and/or transfer of other equipment and/or means or if exit routes are necessary inside the workplace. Refer to par. "B.2.3 Positioning" for information regarding distances from any other machines present in the room (in fact, close proximity can create problems of condensate forming on the walls of the appliance), also taking into consideration the space needed for door opening.

### B.2.3 Positioning

Install the appliance, taking all the safety precautions required for this type of operation, also respecting the relevant fire-prevention measures.

Install the appliance in a ventilated place, away from heat sources such as radiators or air conditioning systems, to allow correct cooling of the refrigerating unit components. When positioning to take into account the following distances:



When positioning to take into account the following distances:

- ▶ at least 50 cm from the top;
- ▶ 30 mm from the back
- ▶ 20 mm (for refrigerated models) and 30mm (for freezer models) from the sides.

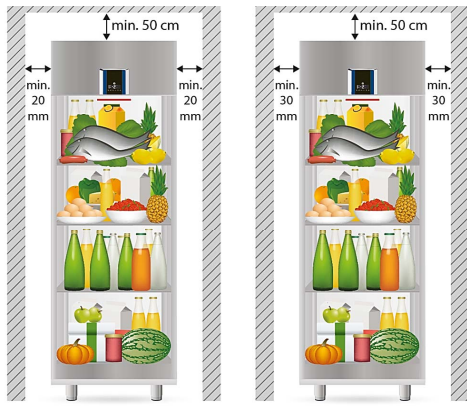

Refrigerated model

Freezer model

**Note:**

For 3-door models take into account the following distances::

- ▶ at least 50 cm from the top;
  - ▶ at least 20 mm from the sides and 100 mm from the back
- Never cover the condenser, even temporarily, as this can compromise proper operation of the condenser and therefore the appliance.

If the machine is installed in a place where there are corrosive substances (chlorine, etc.), it is advisable to go over all the stainless steel surfaces with a rag soaked in paraffin oil to create a protective film.

For information regarding the room temperatures in which the machine must operate, refer to par. A.2.4 "Climatic class". The machine must be taken to the place of installation and the packing base removed only when being installed.

Arranging the machine:

- ▶ position the machine in the required place;
- ▶ adjust the height and levelling with the adjustment feet, also checking correct door closing

**Attention!**  
 **The appliance must be levelled; otherwise its operation could be affected.**

**Attention!**  
 **Wait at least 2 hours before starting the appliance, to allow the oil to flow back in the compressor.**

**Note:**  
 **The plug must be accessible even after the appliance is positioned in the place of installation.**

**Attention!**  
 **There must be free air circulation above the appliance, at the refrigerating unit. There must be no obstructions caused by trays, cardboard boxes, jars or other materials.(see par. C.1.3).**

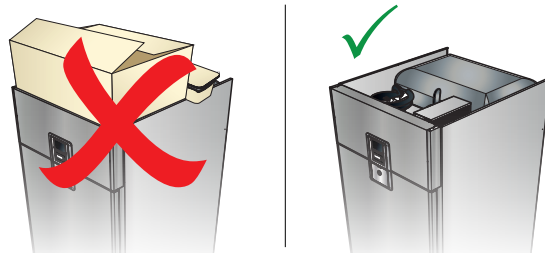



- ▶ wear protective gloves and unpack the machine, carrying out the following operations:
  - cut the straps and remove the protective film, taking care not to scratch the surface if scissors or blades are used;
  - remove the cardboard top, the polystyrene corners and the vertical protection pieces.

For appliances with stainless steel cabinet, remove the protective film very slowly without tearing it, to avoid leaving glue stuck to the surface. Should this happen, remove the traces of glue with a non-corrosive solvent, rinsing it off and drying thoroughly; it is advisable to go over all the stainless steel surfaces with a rag soaked in paraffin oil in order to create a protective film.

**B.2.4 Disposal of packing**

The packing must be disposed of in compliance with the current regulations in the country where the appliance is used.

All the packing materials are environmentally friendly. They can be safely kept, recycled or burned in an appropriate waste incineration plant. Recyclable plastic parts are marked as follows:

 PE	<b>polyethylene:</b> outer wrapping, instruction booklet bag
 PP	<b>polypropylene:</b> straps
 PS	<b>polystyrene foam</b> corner protectors

The parts in wood and cardboard can be disposed of, respecting the current regulations in the country where the machine is used.

**B.2.5 Reversing opening of fully insulated doors**

**Attention!**  
 The user cannot reverse the door opening direction in all models with glass door. Models with glass door come with opening from left to right. To reverse the opening direction, call the After-Sales Service.

**Attention!**  
 Disconnect the appliance from the power supply before carrying out the door reversing procedure.

Single-door refrigerated cupboards are normally supplied with right opening.

When converting to left opening, proceed as follows:

- ▶ open the control panel, loosening the 2 screws located

- ▶ between the panel and door;
- ▶ undo the 2 fixing screws of bracket "A" and the screw securing hinge "B" (detail 1);
- ▶ remove the door and remove hinge "B" from right to left, break the precut "F" on the opposite side and insert part "B" (detail 6) and the bracket as shown in the figure.
- ▶ remove the lower bracket "D", refitting it in the special seat on the opposite side (detail 2);
- ▶ position the door on the lower bracket "D";
- ▶ position the upper bracket "A" between the door and the roof of the appliance, tightening the fixing bolts;
- ▶ before tightening the screws, align the door with the panel of the cabinet, adjusting the lower and upper brackets and making sure the seal is perfectly fitted on all sides;
- ▶ then tighten the bracket fixing bolts.

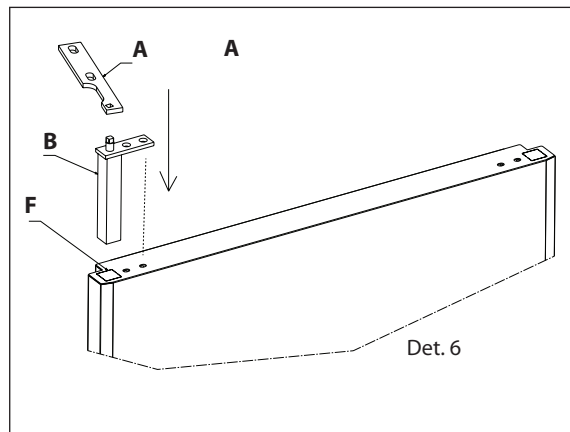
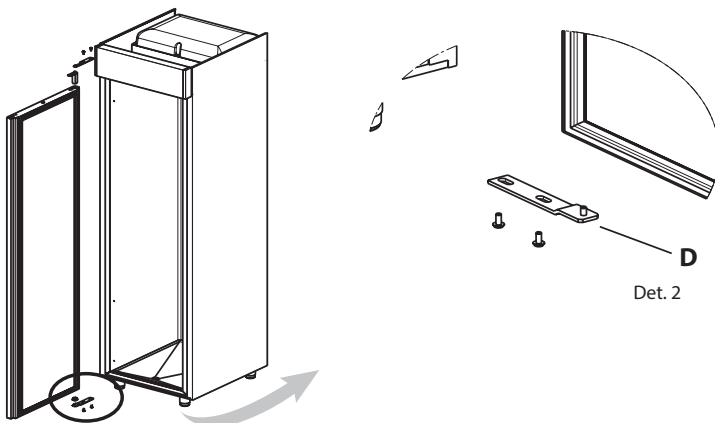
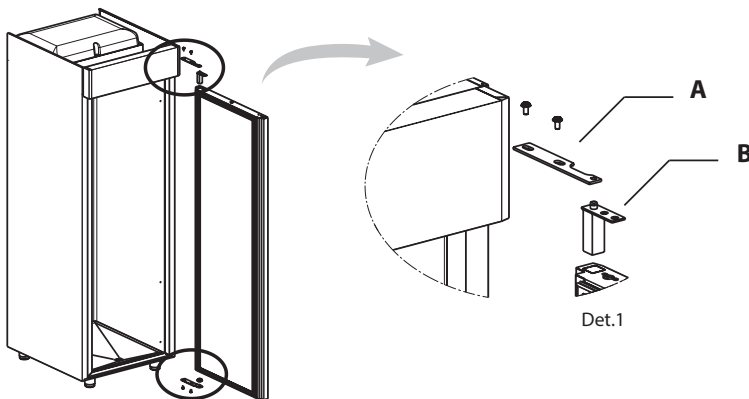

### B.2.6 Reversing opening of half doors

The operations to be carried are those described in the previous section, replacing reference "D" with "F" (detail 3).

- ▶ open the control panel, loosening the 2 screws located between the panel and door;
- ▶ undo the 2 screws fixing bracket "A" and the screw securing hinge "B" of the top door;
- ▶ remove the door and remove hinge "B" from right to left, break the precut "F" on the opposite side and insert part "B" (detail 6) and the bracket as shown in the figure.
- ▶ remove the middle bracket "G" (detail 4) and fix it on the opposite side of the cabinet
- ▶ remove the lower bracket "D", refitting it in the special seat on the opposite side; (detail 5)

- ▶ position the bottom door on the lower bracket "D";
- ▶ fix the middle bracket "E";
- ▶ position the top door on the middle bracket "G";
- ▶ position the upper bracket "A" between the door and the roof of the appliance, tightening the fixing bolts;
- ▶ before tightening the screws, align the door with the panel of the cabinet, adjusting the lower and upper brackets and making sure the seal is perfectly fitted on all sides;
- ▶ then tighten the bracket fixing bolts.

**Note:** After carrying out the above operations, the holes on the appliance must be closed with the specific plastic plugs.

**Note:** In case of installation on a concrete plinth, make 2 holes in the floor near the bottom hinge fixing screws.

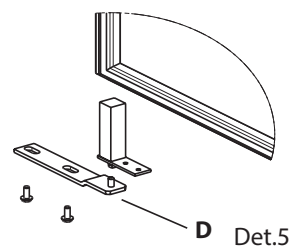
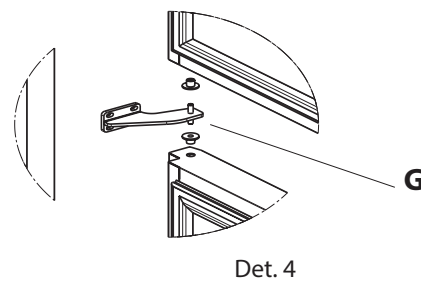
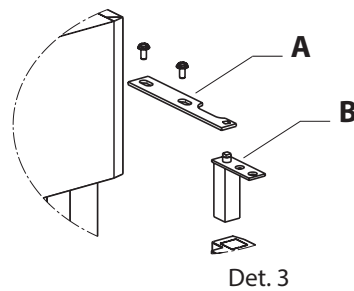
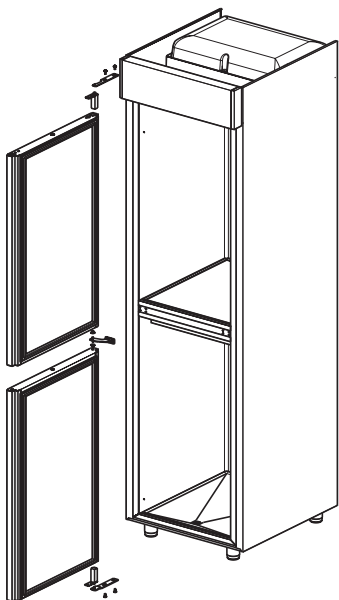
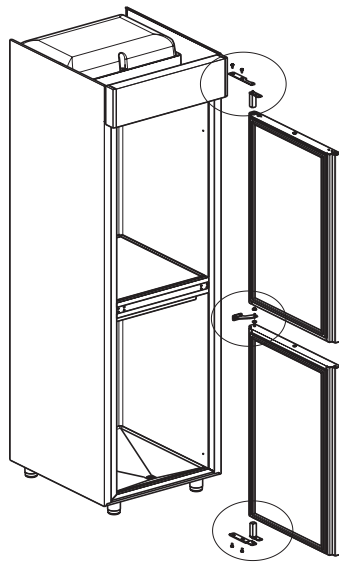

### B.2.7 Electrical connection

Connection to the power supply must be carried out in compliance with the regulations and provisions in force in the country of use.



#### Attention!

**Work on the electrical systems must only be carried out by a qualified electrician.**

The appliance works on a 230V/50Hz or 220V/60Hz, depending on the model, single-phase voltage power supply. For connection, just insert the power cable plug in the corresponding electrical system socket, **firstly making sure:**

- ▶ the socket has an efficient earth connection and the mains frequency matches that given on the dataplate. In case of any doubts regarding the efficiency of the earth connection have the system checked by qualified personnel;
- ▶ the system power supply is arranged and able to take the actual current absorption and that it is correctly executed according to the regulations in force in the country of use;
- ▶ a differential thermal-magnetic switch suitable for the input specified on the dataplate, with contact gap enabling complete disconnection in category III overvoltage conditions and complying with the regulations in force, is installed between the power cable and the electric line. For the correct size of the switch, refer to the absorbed current specified on the appliance dataplate.

After making the connection, with the appliance working check that the power supply does not fluctuate by  $\pm 10\%$  the rated voltage.

### B.2.8 Electrical connection (only for appliances with cable without plug)

Connection to the power supply must be carried out in compliance with the regulations and provisions in force in the country of use.



#### Attention!

**Work on the electrical systems must only be carried out by a qualified electrician.**

The information regarding the appliance power supply voltage is given on the dataplate.

Before connecting, make sure:

- ▶ the connection point has an efficient earth contact and the mains voltage and frequency match that given on the data plate. In case of doubts regarding the efficiency of the earth wire, have the system checked by qualified personnel;
- ▶ the system power supply is arranged and able to take the actual current absorption and that it is correctly executed according to the regulations in force in the country of use;
- ▶ the appliance must be permanently connected to the power supply, respecting the polarities:
  - brown: phase
  - yellow/green: earth
  - blue: neutral;
- ▶ a differential thermal-magnetic switch (or plug) suitable for the absorption specified on the data plate, with contact gap enabling complete disconnection in category III overvoltage conditions and complying with the regulations in force, is installed between the power cable and the electric line. For the correct sizing of the switch or plug, refer to the absorbed

current specified on the appliance data plate. **The chosen device must be lockable in the open position in case of maintenance.**

**ATTENTION: When using a plug, it must comply with the national installation rules. The plug must also be:**

- ▶ accessible after the appliance has been positioned in the place of installation;
  - ▶ in a position always visible to the operator performing the intervention during maintenance operations.
- ▶ After making the connection, with the appliance running check that the power supply does not fluctuate by  $\pm 10\%$  the rated voltage.



#### Attention!

**An H05VV-F power cable (designation 60227 IEC 53) is used for the permanent connection to the power supply; when replacing it, use a type having at least these characteristics.**



#### Attention!

**When replacing the cable, the earth wire must be kept longer than the live and neutral wires.**



**If the power cable is damaged, it must be replaced by the service centre or in any case by qualified personnel, in order prevent any risk. The manufacturer declines any liability for damage or injury resulting from breach of the above rules or non-compliance with the electrical safety regulations in force in the country where the machine is used.**

### B.2.9 Plumbing connection



#### Attention!

**The plumbing connection must be carried out by a specialised technician.**

The machine has a drain hole for any liquids present in the compartment. Connect the compartment drain hole "C", located on the bottom of the appliance and provided with a closing plug, to a drain.

The drain hole diameter is "17.5 mm", therefore it is advisable to connect it to a "17.5 mm" drain pipe.

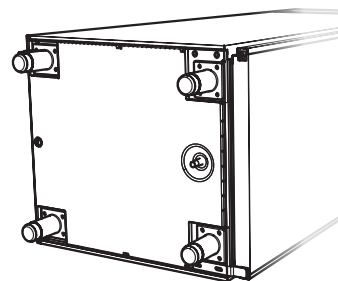



## B.3 Installation of Condensing Unit

**Attention!**  
For the choice of remote condensing unit refer to the unit recommended by the Manufacturer, given on the equipment technical sheet.

**Attention!**  
In case of extraordinary size of the remote condensing unit refer to the technical sheet for the refrigerating capacity data or consult the Manufacturer's website or Local Service Center/ Agency authorized by the Manufacturer.

**Attention!**  
Installation of the appliance and the refrigerant fluid condensing unit must only be carried out by the manufacturer's service personnel or by a qualified person

**Attention!**  
Wear suitable protection equipment (protective gloves) when carrying out installation operation.

Scrupulously follow the instructions given in this section in order to ensure correct appliance operation and maintenance of safety conditions during use.

### B.3.1 Positioning

Put the condenser unit in an adequately ventilated place, as far as possible from heat sources.

Should the remote unit be positioned outdoors, it should be suitably covered to protect it against the elements while guaranteeing correct ventilation of the condenser unit.

The choice of pipes must be made by referring to the technical data given on page 11,13.

Connect the copper pipes, taking care to choose the shortest route and wherever possible avoiding curves, sharp bends and vertical stretches.

It is recommended that the following indications be observed for best appliance efficiency:

- ▶ in the horizontal stretches the suction line should have at least a 2% incline towards the condenser unit;
- ▶ siphons should be installed before each ascending section of the suction line;
- ▶ insulate the suction line using appropriate sheathing;
- ▶ Fit the following on the delivery line in the same order as indicated: a suitably sized dehydrator filter, a liquid flow gauge and a solenoid valve.

**Attention!**  
Pay particular attention to positioning of the pipes for the remote connection of the equipment; avoid making them pass directly above the roof of the evaporator, as shown in the figure:

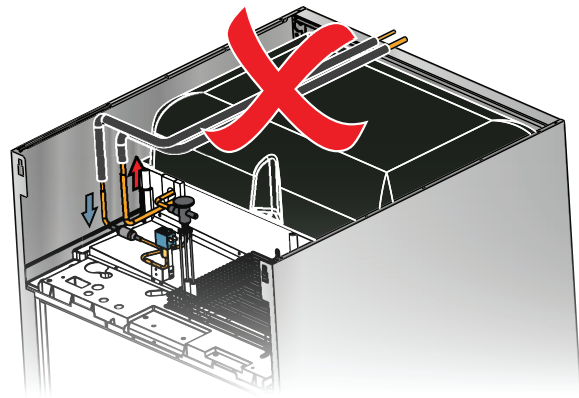

The upper left side has holes for the passage and fixing of the pipes for rear remote connection (figure below):

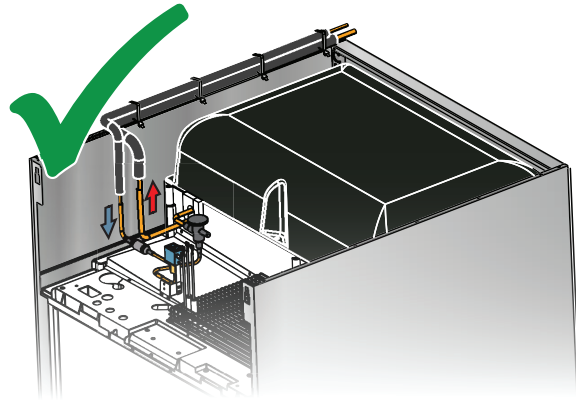

### B.3.2 Responsibility of the customer (installer)

The refrigerant charge must be R134a for refrigerated models and R404a for freezers. In any case refer to the data given on the rating plate.

### B.3.3 Electrical connection

The condensing unit power is supplied by the equipment it is connected to. For the electrical connection, carefully follow the instructions in par. B.2.7.

**Attention!**  
Appliances arranged for connection to the remote unit have an anchoring device for connecting the connection cable to the external unit.

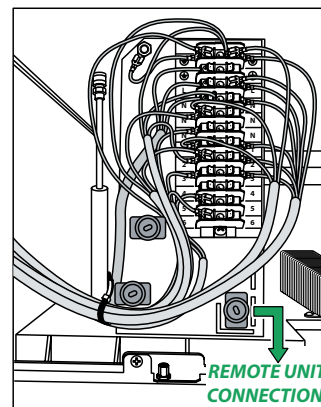



**Attention!**  
The type of relay to be used in installation and the installation system installation itself must comply with the current regulations.



**Attention!**  
230V mains voltage between terminals 1-N.



**Attention!**  
Appliances arranged for connection to remote alarm have an anchoring device for connecting the connection cable of the external siren.

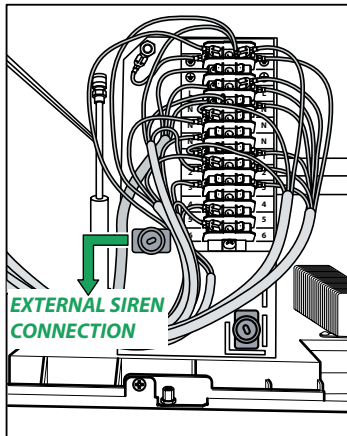

**Attention!**  
230V mains voltage between terminals 4-N.

### B.3.4 Creating a vacuum in the pipes and filling with the refrigerant.

#### B.3.4.1 Leak test

- ▶ Clean the suction and delivery pipes with dry nitrogen under pressure.
- ▶ Connect a nitrogen cylinder to the high and low pressure pipe taps, taking care to install a pressure gauge (using a union-tee). Inject the gas into both the high and the low pressure line until a pressure of approx. 15 bar has been reached. Close the cylinder tap and after a minimum of one hour check that the pressure has not dropped below the previously measured value.

#### B.3.4.2 Vacuum

- ▶ Manually empty the circuit by opening the union taps.
- ▶ Connect the same pipes to a vacuum pump, preferably a double-acting model fitted with a vacuum meter and low and high pressure pipe taps. Reach a vacuum level equal to or less than 70mTorr (0.0931 mbar). Upon reaching the above-mentioned vacuum value, maintain the same for approx. 15 minutes before proceeding to fill the unit as follows:

#### B.3.4.3 Filling with refrigerant

- ▶ Introduce the refrigerant, in the gaseous form for R134a and liquid for R404a, both in the high and the low pressure line until the pressure in the cylinders and in the circuit are balanced (initial liquid load is approx. 20-30% of total load).
- ▶ At this point close the high pressure line, start the compressor and inject gas slowly until the bubbles in the liquid gauge disappear



**Attention!**  
The refrigerant should be loaded by professionally qualified personnel.

#### B.3.5 Controls at first start-up of the system

Using the liquid refrigerant flow gauge, check that the load is sufficient. If it is not, complete the load following the instructions given in § 3.4.3.

Using a digital thermometer, check that the temperature indicated on the control panel corresponds to the reading on the instrument placed inside the appliance.

**The manufacturer cannot be held liable should these accident-prevention rules and regulations not be observed.**

# C.1 Operation of digital models

## C.1.1 Digital thermoregulator and control panel

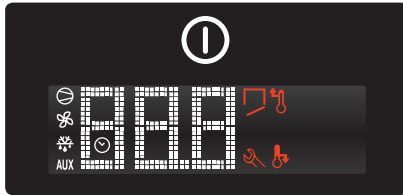

Fig. 1

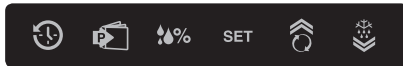
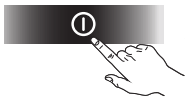

Fig. 2

The digital thermoregulator has a button for switching the appliance on and off (fig.1) and 6 buttons for control and programming the instruments (see fig. 2).

### C.1.1.1 Switching the appliance on



Connect the power cable to a power socket. The instrument display performs a Lamp Test and the message OFF will appear. To activate and deactivate the appliance press the button. for 5 seconds. The display will show the message **ON**(for activation) or **OFF** (for deactivation).Even if the machine is deactivated with the ON/OFF button it still remains powered. This button only disconnects the power to the loads connected to the instrument.

### C.1.1.2 Control panel buttons (fig. 2)

#### History button



Records the temperature every 24 hours from activation, for a total of 62 saves. Records high/low temperature alarms.



The first press of the History button brings up the list of daily recorded values (t00=current day;t01,t02,t03,etc.=recording days going back).Use the buttons to display the temperatures of previous days.



Press the **Set** button to display the recorded temperature of that period;to return to the list of stored values press the button **P**.



Press the button **P** for a few seconds to exit the History function.At least 24 hours must pass after installation of the appliance before the first temperature can be recorded.



Keeping the button pressed for a few seconds resets the previous recordings.



#### Programmes button

It is used in the HISTORY function (see par. C.1.1.2).

Pressing the button **P** also brings up the Technical Menu, which cannot be modified.

#### Humidity button



Present only on refrigerated models, it is used to set 3 different humidity levels. Depending on the humidity level, the display will show the images with 1, 2 or 3 lines that indicate: low, medium and high humidity.

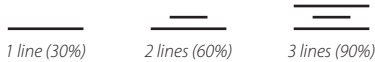

Use the buttons to select the most suitable humidity level.

### Table of categories, compartment temperature and humidity setting

Categories	Temp.°C	Humidity
Fresh meat (beef, mutton, pork)	4	90%
Poultry	-2	90%
Fruit & Vegetables	6	90%
Eggs, Butter, Cheese, Charcuterie	6	90%
Fresh fish	4	90%
Patisserie	6	90%
Beverages	8	60%



To confirm the degree of humidity selected, press the button **P** for 5 seconds.



#### Set button

Press for more than 1 second to display and/or set the **setpoint**. To increase or decrease the values use the buttons.



To confirm the new value, press the Set button



#### Continuous cycle button

Press the button for more than 5 seconds to activate the Turbo Cooling "TC" cycle function (the message ccb=start appears); the temperature reinstatement function is activated, skipping Defrost.

During the continuous cycle the compressor remains on; the low temperature alarm is deactivated; the message TC and the temperature value alternate on the display. The continuous cycle ends:

- ▶ when the button is pressed (the



- ▶ message cce=end appears);
- ▶ when the min. foreseen temperature is reached;
- ▶ when the max. duration (time 1h) is reached; when the instrument is switched off.



**“Up” button**  
for increasing the values



**“Down” button**  
for decreasing the values

ues

**Defrost button**



**Attention!**  
**Do not use mechanical devices or other means to speed up the defrost process, unless recommended by the manufacturer.**

**Attention!**  
**Do not damage the circuit**

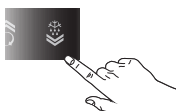

The appliance has an automatic defrost function. A manual defrost cycle can be started by keeping the button pressed for at least 5 seconds (the display shows the message **DFb**).



This function is signalled by lighting up of the defrost icon. Defrost is with forced ventilation only for refrigerated models with compartment set point higher than or equal to “+2”

Defrost can be stopped manually by pressing the button for a few seconds (the display shows the message “**dFE**”). Defrost cannot be activated in the continuous cycle programming phase\*



\*If the continuous cycle is activated and the button is pressed, defrost will be carried out at the end.

**Light button**



Present in models with glass door, its purpose is to switch on the inside light. In freezer models with fully insulated door, it changes the brightness of the compartment light.

**C.1.2.2 Digital thermoregulator display**

The digital thermoregulator has a 3-digit electronic display and seven signalling icons (see fig.1)



lit up indicates compressor activation



lit up indicates the defrost function



lit up indicates activation of compartment fans



lit up signals useful information regarding appliance operation (alarms)

*aux*

lit up indicates activation of auxiliary users (if present)



lit up indicates HISTORY function on

**C.1.3 Alarms and signalling**



The message is signalled by lighting up of the icon. The alarm icons are also associated with the colour of the lamp which changes when there is an alarm (red). Signalling also occurs with the respective code appearing on the display and the activation of an audible alarm.

**C.1.3.1 Alarm silencing**

Alarms are silenced by pressing on the lit icon. The value indicated on the display is also automatically reset.

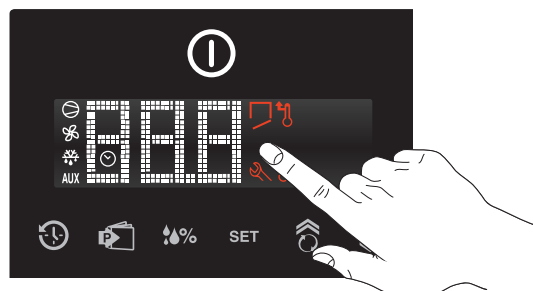

**C.1.3.2 Alarm icons**

**Compartment high temperature alarm**



The icon lights up and an audible alarm sounds when the compartment temperature exceeds the set maximum value. The alarm ceases when the temperature returns to the Set Point. A timer, which counts the alarm duration time until it is silenced, is also activated.



Pressing the History button displays the code HI and then in sequence, pressing the button “**set**” the number of hours since the alarm occurred.

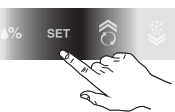

To deactivate the icon, briefly press on it.

**Compartment low temperature alarm**



The icon lights up and an audible alarm

is activated when the compartment temperature exceeds the set minimum value. The alarm ceases when the temperature returns to the Set Point. A timer, which counts the alarm duration time until it is silenced, is also activated.



Pressing the History button displays the code LO and then in sequence, pressing the button "set", the number of days since the alarm occurred. To deactivate the icon, briefly press on it.



### Door open alarm



The icon lights up when the door is opened. After the max. door opening time the icon stays on fixed and the buzzer is activated. The alarm ceases when the door is closed.



### Service alarms

Symbols	Meaning	What to do
E0 "rE"	Compartment sensor fault	<b>call service centre</b>
E1	Room probe fault	
E2	Condenser sensor fault	
CLN (*)	The condenser needs cleaning	
"Ser"	Condenser fan failure	
CN	Communication between thermoregulator and compartment lamp interrupted	

(\*)If the message "CLn" appears, firstly make sure there are no obstructions on top of the machine; otherwise, they must be immediately removed. Then, after the signalling is reset, check if the condenser is very dirty and clean it if necessary (operation not requiring After-Sales Service).

**Note:** The signalling message "CLn" is factory-set in maximum room temperature operating conditions (43°C) and considering the condenser completely obstructed.

### C.1.4 Product loading

Distribute the product evenly inside the compartment (away from the door and back) to allow good air circulation.

In case of excessive product loading, the temperature remains uniform thanks to the removable rear supports which act as an air conveyor.

Cover or wrap food before placing it in the refrigerator and avoid putting very hot foods or steaming liquids inside.

Do not leave the door open any longer than necessary when loading or removing food. It is advisable to keep the keys in a place only accessible to authorised personnel.

To prevent unauthorised personnel from using the appliance, it is advisable to always close it with the key.



#### Attention!

**Do not use electrical appliances inside the appliance compartments for storing frozen food, unless such equipment is recommended by the manufacturer.**

Regarding the max. load for each shelf, respect that given in the table below

<b>Shelf max. load</b>	
vertical refrigerators with digital control	<b>54 Kg</b>

## C.2 General safety rules

### C.2.1 Introduction

The machines are provided with electric and/or mechanical safety devices for protecting workers and the machine itself. Therefore the user must not remove or tamper with such devices.

The Manufacturer declines any liability for damage due to tampering or their non-use.

### C.2.2 Protection devices installed on the machine

#### C.2.2.1 Guards

The guards on the machine are:





- ▶ fixed guards (e.g. casings, covers, side panels, etc.), fixed to the machine and/or frame with screws or quick-release connectors that can only be removed or opened with tools;
- ▶ interlocked movable guards (door) for access inside the machine;
- ▶ machine electrical equipment access doors, made with hinged panels openable with tools. The door must not be opened when the machine is connected to the power supply.



#### Attention!

Several illustrations in the manual show the machine, or parts of it, without guards or with guards removed. This is purely for explanatory purposes. Do not use the machine without the guards or with the protection devices deactivated.

### C.2.3 Safety signs to be placed on the machine or near its area

Prohibition	Meaning
	Do not remove the safety devices
	Do not use water to extinguish fires (shown on electrical parts)
Danger	Meaning
	danger of burns
	danger of electrocution (shown on electrical parts with indication of voltage)



#### Attention!

Do not remove, tamper with or make illegible the safety, danger and instruction signs and labels on the machine.

### C.2.4 End of use

When the appliance is no longer to be used, make it unusable by removing the power supply wiring.

### C.2.5 Instructions for use and maintenance

Risks mainly of a mechanical, thermal and electrical nature are present in the machine.

Where possible the risks have been neutralised:

- ▶ directly, by means of adequate design solutions,
- ▶ or indirectly by using guards, protection and safety devices.

Any anomalous situations are signalled on the control panel display.

During maintenance several risks remain, as these could not be eliminated, and must be neutralised by adopting specific measures and precautions.

Do not carry out any checking, cleaning, repair or maintenance operations on moving parts.

Workers must be informed of the prohibition by means of clearly visible signs. To guarantee machine efficiency and correct operation, periodical maintenance must be carried out according to the instructions given in this manual. In particular, make sure to periodically check correct operation of all the safety devices and the insulation of electrical cables, which must be replaced if damaged.



#### Attention!

Extraordinary machine maintenance operations must only be carried out by specialised Technicians provided with all the appropriate personal protection equipment (safety shoes, gloves, glasses, overalls, etc.), tools, utensils and ancillary means.



#### Attention!

Never operate the machine, removing, modifying or tampering with the guards, protection or safety devices.



#### Attention!

Before carrying out any operation on the machine, always consult the manual which gives the correct procedures and contains important information on safety.

### C.2.6 Reasonably foreseeable improper use

Improper use is any use different from that specified in this manual. During machine operation, other types of work or activities deemed improper and that in general can involve risks for the safety of operators and damage to the appliance are not allowed.

Reasonably foreseeable improper use includes:

- ▶ lack of machine maintenance, cleaning and periodical checks;
- ▶ structural changes or modifications to the operating logic;
- ▶ tampering with the guards or safety devices;
- ▶ failure to use personal protection equipment by operators, specialised technicians and maintenance personnel;
- ▶ failure to use suitable accessories (e.g. use of unsuitable equipment or ladders);
- ▶ keeping combustible or flammable materials, or in any case materials not compatible with or pertinent to the work, near the machine;
- ▶ wrong machine installation;
- ▶ placing in the machine any objects or things not compatible with refrigeration, freezing or preservation, or that can damage the machine, cause injury or pollute the environment;
- ▶ climbing on the machine;
- ▶ non-compliance with the requirements for correct machine use;
- ▶ other actions that give rise to risks not eliminable by the Manufacturer.



**Attention!**  
**The previously described actions are prohibited!**

### C.2.7 Residual risks

The machine has several risks that were not completely eliminated from a design standpoint or with the installation of adequate protection devices.

Nevertheless, through this manual the Manufacturer has taken steps to inform operators of such risks, carefully indicating the personal protection equipment to be used by them.

Sufficient spaces are provided for during the machine installation stages in order to limit these risks.

To preserve these conditions, the areas around the machine must always be:

- ▶ kept free of obstacles (e.g. ladders, tools, containers, boxes, etc.);
- ▶ clean and dry;
- ▶ well lit.

For the Customer's complete information, the residual risks remaining on the machine are indicated below: such actions are to be considered incorrect and therefore strictly forbidden.

<b>Residual risk</b>	<b>Description of hazardous situation</b>
Slipping or falling	The operator can slip due to water or dirt on the floor.
Burns/abrasions (e.g. heating elements, cold tray, cooling circuit plates and pipes)	The operator deliberately or unintentionally touches some components inside the machine without using protective gloves.
Electrocution	Contact with live parts during maintenance operations carried out with the electrical panel powered.
Falling from above	The operator works on the machine using unsuitable systems (e.g. rung ladders, climbing) to access the upper part.
Crushing or injury	The specialised Technician may not correctly fix the control panel when accessing the technical compartment. The panel could close suddenly.
Tipping of loads	When handling the machine or the packing containing it, using unsuitable lifting systems or accessories or with the load unbalanced.
Chemical (refrigerant gas)	Inhalation of refrigerant gas. Therefore always refer to the appliance labels.



## C.3 Normal machine use

### C.3.1 Characteristics of personnel trained for normal machine use

The Customer must make sure the personnel for normal machine use are adequately trained and skilled in their duties, as well as ensuring their own safety and that of other persons. The Customer must make sure his personnel have understood the instructions received and in particular those regarding work hygiene and safety in use of the machine.

### C.3.2 Characteristics of personnel enabled to operate on the machine

The Customer is responsible for ensuring that persons assigned to the various duties:

- ▶ read and understand the manual;
- ▶ receive adequate training and instruction for their duties in order to perform them safely;
- ▶ receive specific training for correct machine use.

### C.3.3 Operator for normal machine use

He must have at least:

- ▶ knowledge of the technology and specific experience in operating the machine;
- ▶ adequate general basic education and technical knowledge for reading and understanding the contents of the manual;
- ▶ including correct interpretation of the drawings, signs and pictograms;
- ▶ sufficient technical knowledge for safely performing his duties as specified in the manual;
- ▶ knowledge of the regulations on work hygiene and safety.

In case of a significant anomaly (e.g. short circuits, wires coming out of the terminal block, motor breakdowns, worn electrical cable sheathing, etc.) the operator for normal machine use must:

- ▶ immediately deactivate the machine.

## D.1 Machine cleaning and maintenance



### Attention!

**Before carrying out any cleaning or maintenance operation, disconnect the appliance from the power supply and carefully unplug it.**



### Attention!

**During maintenance, the cable and plug must be kept in a visible position by the operator carrying out the work.**



### Attention!

**Do not touch the appliance with wet hands or feet or when barefoot.  
Do not remove the safety guards.**



### Attention!

**Use suitable personal protection equipment (protective gloves)**



### Attention!

**Use a ladder with suitable protection for work on appliances with high accessibility.**

### D.1.1 Routine maintenance



### Attention!

**Disconnect the power supply before cleaning the appliance.**

#### D.1.1.1 Precautions for maintenance

Routine maintenance operations can be carried out by non-specialised personnel, carefully following the instructions given below. **The manufacturer declines any liability for operations carried out on the appliance without following these instructions.**

#### D.1.1.2 Cleaning the cabinet and accessories

Before using the appliance, clean all the inside parts and accessories with lukewarm water and neutral soap or products that are over 90% biodegradable (in order to reduce the emission of pollutants into the environment), then rinse and dry thoroughly.

Do not use solvent-based detergents (e.g. trichloro-ethylene) or abrasive powders for cleaning.

It is advisable to go over the stainless steel surfaces with a rag moistened with paraffin oil in order to create a protective film. Check the power cable regularly and replace it in case of signs of wear.

Have the appliance checked periodically (at least once a year).





**Attention!**  
Do not clean the machine with jets of water.



**Attention!**  
Do not use steel wool or similar material to clean stainless steel surfaces. Do not use detergents containing chlorine, solvent-based detergents (e.g. trichloro-ethylene) or abrasive powders.



### D.1.1.3 Compartment cleaning

The racks can be removed in order to thoroughly clean the compartment, therefore remove them before cleaning. For this, use products that are over 90% biodegradable (do not use solvents or abrasive powders), then rinse and dry thoroughly. Lastly, remove the plug closing the drain hole (refrigerated models only) and drain the water (only if it is connected, see section B.2.8). Pay special attention when cleaning the front control panel: make sure water sprays do not go beyond the panel.

#### ATTENTION:

There is an extra rack on the bottom of the compartment. When cleaning, if this rack is temporarily removed, remember to refit it in its original place, as shown in the figure (detail "c"), in order to ensure proper operation of the appliance:

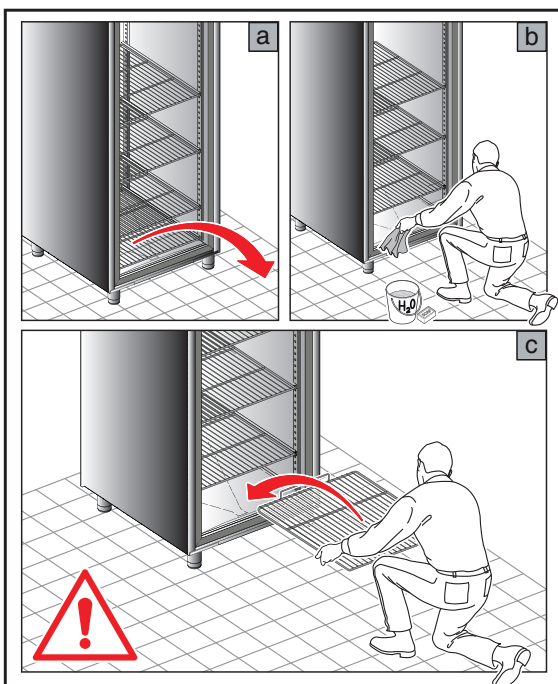

### D.1.1.4 Precautions in case of long idle periods

If the appliance is not going to be used for some time, take the following precautions:

- ▶ remove the plug from the power socket;
- ▶ remove all food from the compartment and clean the inside and accessories;
- ▶ clean the cabinet, going over all the stainless steel surfaces vigorously with a cloth moistened with paraffin oil in order to create a protective film;
- ▶ leave the door ajar so that air can circulate inside, preventing the formation of unpleasant odours.
- ▶ air the premises periodically.



**Attention!**  
Machine maintenance, checking and overhaul operations must only be carried out by a specialised Technician or the After-Sales Service, provided with adequate personal protection equipment (safety shoes and gloves), tools and ancillary means.



**Attention!**  
Work on the electrical equipment must only be carried out by a specialised electrician or the After-Sales Service



**Attention!**  
Put the machine in safe conditions before starting any maintenance operation.

After carrying out maintenance make sure the machine is able to work safely and, in particular, that the protection and safety devices are efficient.



**Attention!**  
Respect the requirements for the various routine and extraordinary maintenance operations. Non-compliance with the instructions can create risks for personnel

### D.1.2 Extraordinary maintenance



**Attention!**  
Wear protective gloves and a mask when carrying out any extraordinary maintenance operations.

**Extraordinary maintenance must be carried out by specialised personnel, who can ask the manufacturer to supply a servicing manual.**

#### D.1.2.1 Periodical condenser cleaning

Periodical cleaning of the equipment depends on the frequency of its use.



**Pay attention to the electrical cables!**

Make sure not to obstruct the air passage on models with wire and tube condenser (located in the roof of the machine). This type of condenser does not require cleaning and does not lose its efficiency over time. To ensure optimum appliance operation clean the refrigerating unit condenser at least once every three months.

**Note:** It is advisable to use a brush or vacuum cleaner to remove the dirt accumulated on the condenser. Do not use sharp objects, which could damage the condenser

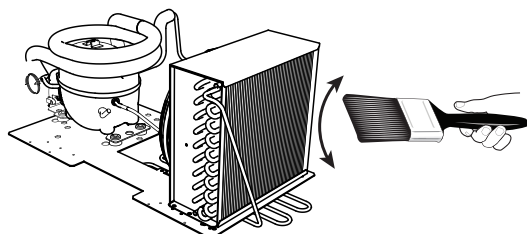

### D.1.2.2 Replacing the power cable

To replace the power cable, proceed as follows:

- ▶ disconnect the power supply;
- ▶ lift the control panel and make sure it is blocked (it is advisable to fix it with adhesive tape);
- ▶ remove the electrical box plastic cover;
- ▶ replace the power cable;
- ▶ refit the electrical box plastic cover and lower the control panel;
- ▶ reconnect the power supply.

### D.1.2.3 Quick troubleshooting guide

In some cases, faults can be eliminated easily and quickly by following a brief troubleshooting guide:

- A. The appliance does not switch on:**
  - ▶ make sure the plug is properly inserted in power socket.
  - ▶ make sure the socket is powered.
- B. The inside temperature is too high:**
  - ▶ make sure there is no heat source near the appliance;
  - ▶ make sure the door closes properly.
- C. The appliance is too noisy:**
  - ▶ make sure the appliance is properly levelled. An unbalanced position can set off vibrations.
  - ▶ make sure the appliance is not touching other appliances or parts which could reverberate.

If the fault persists after carrying out the above checks, contact the After-Sales Service, remembering to give the following details:

- ▶ the type of fault;
- ▶ the appliance PNC (production code);
- ▶ the Ser. No. (appliance serial number).

**Note: The code and serial number are essential for identifying the type of appliance and date of manufacture:**

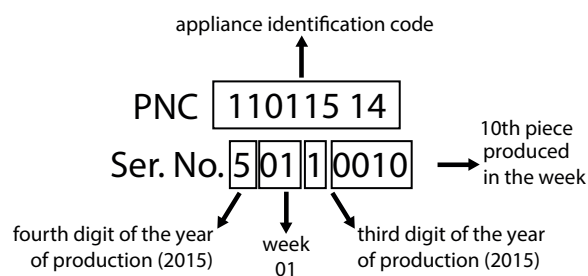

### D.1.3 Maintenance intervals

The inspection and maintenance intervals depend on the actual machine operation conditions and ambient conditions (presence of dust, damp, etc.), therefore precise time intervals cannot be given. In any case, careful and periodical machine maintenance is advisable in order to minimise interruptions of the service.

**It is advisable to stipulate a scheduled preventive maintenance contract with the After-Sales Service.**

#### D.1.3.1 Maintenance frequency

In order to guarantee constant machine efficiency, it is advisable to carry out the checks with the frequency given in the following table:

Maintenance, checks, inspections and cleaning	Periodicità
<b>Routine cleaning</b> General cleaning of machine and surrounding area	<b>Daily</b>
<b>Mechanical protection devices</b> Check condition, and for any deformation, loosening or removed parts.	<b>Monthly</b>
<b>Control</b> Check mechanical part, for any breakage or deformation, tightening of screws. Check readability and condition of words, stickers and symbols and restore if necessary.	<b>Yearly</b>
<b>Machine structure</b> Tightening of main bolts (screws, fixing systems, etc.) of machine.	<b>Yearly</b>
<b>Safety signs</b> Check readability and condition of safety signs.	<b>Yearly</b>
<b>Electrical control panel</b> Check the electrical components installed inside the Electric Control Panel. Check wiring between the Electrical Panel and machine parts.	<b>Yearly</b>
<b>Electrical connection cable and plug</b> Check connection cable (replace it if necessary) and plug.	<b>Yearly</b>
<b>General machine overhaul</b> Check all components, electrical equipment, corrosion, pipes,...	<b>Every 10 years (*)</b>

(\*) the machine is designed and built for a duration of about 10 years. After this period of time (from machine commissioning) the machine must undergo a general inspection and overhaul. Some examples of checks to be carried out are given below.

- ▶ check for any oxidised electrical components or parts; if necessary, replace them and restore the initial conditions;
- ▶ check the structure and welded joints in particular;

- ▶ check and replace bolts and/or screws, also checking for any loose components;
- ▶ check the electrical and electronic system;
- ▶ check the functionality of safety devices;
- ▶ check the general condition of protection devices and guards.

**Attention!**  
**Machine maintenance, checking and overhaul operations must only be carried out by a specialised Technician or the After-Sales Service, provided with adequate personal protection equipment (safety shoes and gloves), tools and ancillary means.**

**Attention!**  
**Work on the electrical equipment must only be carried out by a specialised electrician or the After-Sales Service.**

#### D.1.4 Disassembly

If the appliance has to be disassembled and then reassembled, make sure the various parts are assembled in the correct order (if necessary mark them during disassembly).

Before disassembling the machine, make sure to carefully check its physical condition, and in particular any parts of the structure that can give or break. Before starting disassembly:

- ▶ remove all the pieces (if present) in the machine;
- ▶ disconnect the power supply;
- ▶ enclose the work area;
- ▶ place a sign on the Main Electrical Panel indicating that the machine is undergoing maintenance and not to carry out manoeuvres;
- ▶ carry out the disassembly operations.

**Attention!**  
**All scrapping operations must occur with the machine stopped and cold and the electrical power supply disconnected.**

**Attention!**  
**Work on the electrical equipment must only be carried out by a qualified electrician, with the power supply disconnected.**

**Attention!**  
**To carry out these operations, appropriate PPE must be used.**

**Attention!**  
**During disassembly and handling of the various parts, the minimum height from the floor must be maintained.**

#### D.1.5 Decommissioning

If the machine cannot be repaired, carry out the decommissioning operations, signalling the failure with a suitable sign, and request assistance of the manufacturer's after-sales service.

## D.2 Machine disposal

**Attention!**  
**Dismantling operations must be carried out by qualified personnel.**

**Attention!**  
**Work on the electrical equipment must only be carried out by a qualified electrician, with the power supply disconnected.**

#### D.2.1 Waste storage

At the end of the product's life-cycle, make sure it is not dispersed in the environment. The doors must be removed before scrapping the appliance.

Special waste materials can be stored temporarily while awaiting treatment for disposal and/or permanent storage. In any case, the current environmental protection laws in the country of use must be observed.

#### D.2.2 Procedure regarding appliance dismantling macro operations

Before disposing of the machine, make sure to carefully check its physical condition, and in particular any parts of the structure that can give or break during scrapping.

The machine's parts must be disposed of in a differentiated way, according to their different characteristics (e.g. metals, oils, greases, plastic, rubber, etc.).

Different regulations are in force in the various countries, therefore comply with the provisions of the laws and competent bodies in the country where scrapping takes place.

In general, the appliance must be taken to a specialised collection/scrapping centre.

Dismantle the appliance, grouping the components according to their chemical characteristics, remembering that the compressor contains lubricant oil and refrigerant fluid which can be recycled, and that the refrigerator components are special waste assimilable with urban waste.

 The symbol placed on the product indicates that it should not be considered as domestic waste, but must be correctly disposed of in order to prevent any negative consequences for the environment and the health of people. For further information on the recycling of this product, contact the local dealer or agent, the after-sales service or the local body responsible for waste disposal.

**Attention!**  
**Make the appliance unusable by removing the power cable and any compartment closing devices, to prevent the possibility of someone becoming trapped inside.**

**Attention!**  
**When scrapping the machine, the "CE" marking, this manual and other documents concerning the machine must be destroyed.**

### **D.3 Enclosed documents**

---

- ▶ Set of test and inspection documents
- ▶ Wiring diagram
- ▶ Installation diagram